

/ UPDATE  
CATALOGUE /



/ UPDATE  
CATALOGUE /



## / INDEX

006 - H\_HAMMAM  
022 - HIDDEN  
028 - MAKRO SYSTEMS  
046 - LOFT  
050 - SUITE  
054 - MY STYLE . CORIAN® DEEP NOCTURNE  
058 - LOOK . CORIAN® DEEP NOCTURNE  
060 - TENDER  
064 - FLAT + UP . ECOCEMENTO  
072 - WAVE . ECOCEMENTO  
076 - SHADE  
082 - MATERIAL TABLE  
086 - EGO  
090 - OX  
098 - SOFFIONI . SHOWER HEADS . KOPFBRAUSE  
102 - TWENTY  
108 - TYPE COLLECTION  
114 - LAVABI . WASHBASINS . WASCHTISCHE

## / IDEA

Prodotti innovativi e coerenti in linea con i principi del design e della cultura del progetto sono gli assunti della filosofia di Makro. Tali fondamentali, rafforzati negli anni, hanno consentito di sviluppare nuovi percorsi di ricerca capaci di suggerire proposte e offrire prodotti in grado di soddisfare sia le richieste tecniche e progettuali di architetti e interior designers, sia la domanda di una clientela attenta ed esigente. Singoli prodotti e soluzioni uniche, in grado di contaminare la stanza da bagno e gli ambiti ad esso correlati, sono le proposte che Makro offre al mercato globale.

New and coherent products in line with the principles of design and of the project culture are the basis of the Makro philosophy. The above mentioned basis, strengthened over the years, led to the development of new research paths, suggesting products able to meet not only the technical and project requirements of architects and interior designers, but also the needs of demanding clients. Single products and integrated solutions, able to influence the bathroom and the related areas, are what Makro suggests to the global market.

Erneuernde und folgerichtige Produkte in Linie mit den Grundsätzen von Design und Projektkultur, sind die Fundamente der Makro Philosophie. Die oben genannten Grundsätze, verstärkt im Laufe der Jahre, ermöglichten die Entwicklung von Forschungsprojekten, welche neue Produkte vorgeschlagen haben, die sowohl die technischen und die Projektansprüche von Architekten und Interior Designers, als auch die Bedürfnisse von anspruchsvollen Kunden treffen können. Einzelne Produkte oder integrierte Vereinigungen, die das Badezimmer und die verbundenen Räume beeinflussen, sind die Vorschläge, die Makro dem globalen Markt anbietet.

/ H\_HAMMAM  
DESIGN . GIULIO GIANTURCO & MAKRODESIGN



/ H\_HAMMAM

H\_HAMMAM è l'innovativo bagno turco per l'ambiente domestico e per l'hotellerie, disegnato da Giulio Gianurco con Makrodesign. Esclusivo e purissimo nelle linee, H\_HAMMAM si distingue per design, eleganza e personalità grazie alla cura di ogni dettaglio, alla sua struttura in alluminio composito che ne consente il posizionamento freestanding, alla ricca dotazione di accessori e alle prestazioni particolarmente performanti. E' proposto in una vasta gamma di finiture sia tecniche (Corian® Glacier White e vetro) che materiche (marmo e legno termotrattato), mentre in versione da rivestire offre l'opportunità della massima personalizzazione.

H\_HAMMAM is the innovative steambath for the home and hotel sector resulting from the cooperation between Giulio Gianurco and Makrodesign. Exclusive and with pure lines, H\_HAMMAM is characterized by design, elegance and personality thanks to the details care, its structure in composite aluminium allowing several installation typologies, the rich range of accessories and its high performance. It is available in a wide range of finishes, such as Corian® Glacier White, glass, marble and thermo-treated wood, but it can be supplied also unclad offering several customization opportunities.

H\_HAMMAM ist ein neues Dampfbad fuer den Privat- und Hotel Bereich, das das Ergebnis der Zusammenarbeit von Giulio Gianurco und Makrodesign ist. Exklusiv und pur, ist H\_HAMMAM gekennzeichnet durch Design, Eleganz und Persoenlichkeit dank der Liebe zum Detail, seiner Struktur aus Aluminiumverbundplatten, die verschiedene Installationsmoeglichkeiten erlaubt, der umfangreichen Palette von Zubehoeren und seiner Leistungsfahigkeit. Es ist in verschiedenen Ausfuerungen, wie Corian® Glacier White, Glass und thermo-behandeltem Holz, oder ohne Verkleidung erhaltlich und bietet zahlreiche Personalisierungsmoeglichkeiten an.







/ H\_HAMMAM





H\_HAMMAM in Marmo Bianco di Carrara e legno Lati termotrattato per ambienti classici e contemporanei.

-  
H\_HAMMAM in White Carrara marble and in Lati thermo-treated wood for classic and contemporary environments.

-  
H\_HAMMAM in weißem Carrara-Marmor und thermo-behandeltem Holz Lati fuer klassische und zeitgenoessische Raeume.







/ H\_HAMMAM

Rivestimenti in legno Hemlock termotrattato e marmo Bianco di Carrara per H\_HAMMAM freestanding.

Claddings in Hemlock thermo-treated wood and White Carrara marble for freestanding H\_HAMMAM.

Verkleidung in thermo-behandeltem Holz Hemlock und weißem Carrara-Marmor fuer H\_HAMMAM freistehend.



Freestanding o in sistema con i prodotti di collezione, H\_HAMMAM è proposto in diversi modelli personalizzabili in un'ampia gamma di finiture coordinate.

Freestanding or integrated with other collection's products, H\_HAMMAM is available in several models customizable with different finishes.

Freistehend oder integriert mit anderen Produkten der Kollektion, ist H\_HAMMAM in verschiedenen personalisierbaren Modellen vorgeschlagen.





/ H\_HAMMAM







/ H\_HAMMAM

H\_HAMMAM si propone al mondo dell'architettura per il design e per il forte contributo progettuale in termini di configurabilità, personalizzazione e semplicità di installazione.

H\_HAMMAM addresses the world of architecture for its design and for the strong project contribution in terms of typology, customization and easiness of installation.

H\_HAMMAM wendet sich an die Welt der Architektur dank seinem Design und dem wichtigen Projektbeitrag hinsichtlich seiner Komposition, Personalisierung und einfacher Installation.



La gestione elettronica delle funzioni è ottimizzata da un intuitivo pannello Touch dal design minimale. Le icone retroilluminate facilitano la selezione e la attivazione di temperatura, colore e musica.

The electronic management of the functions is optimized thanks to an intuitive minimal Touch screen. The backlight icons ease the selection and activation of temperature, color and music.

Die elektronische Bedienung der Funktionen wird dank eines intuitiven und minimalen Touch Screens optimalisiert. Mittels hinterleuchteter Icons werden die Temperatur, Farben und Musik ausgewählt und betätigt.





Gli accessori, di linea pura ed essenziale, sono in Corian® Glacier White e acciaio inox. La panca sospesa garantisce massima igiene; ruotata, offre un importante spazio aggiunto. H\_HAMMAM è dotato inoltre, di sistema cromoterapico a led con pannello di comando Touch a parete.

The accessories, displaying a pure and essential line, are in Corian® Glacier White and in stainless steel. The hygienical suspended seat can be rotated increasing the space available. H\_HAMMAM is equipped with Led chrome-therapy system with wall Touch command.

Die puren und wesentlichen Zubehoere sind in Corian® Glacier White und Inox-Stahl. Der wandhaengende Kippsitz erweitert den verfügbaren Raum. H\_HAMMAM ist ausgestattet mit Led Fartherapie mit Wand-Touch Screen.



/ LIGHT COLOURS SYSTEM

Le rarefatte atmosfere che avvolgono lo spazio interno di H\_HAMMAM, fusione di vapore e colore, sono facilmente gestite dal pannello di controllo touch, dal design essenziale.

The rarified atmosphere of steam and color inside H\_HAMMAM can be easily handled thanks to the intuitive touch screen.

Dampf- und Farbensystem von H\_HAMMAM werden mittels eines intuitiven Touch Screens bedient.



RIVESTIMENTI ESTERNI . OUTSIDE CLADDING  
. AUSSENVERKLEIDUNG

H\_HAMMAM può essere personalizzato con rivestimenti di collezione in legno termotrattato e Corian® Glacier White.

H\_HAMMAM can be customized with claddings in thermo-treated wood and Corian® Glacier White.

H\_Hammam kann mit Verkleidungen wie Holz und Corian® Glacier White personalisiert werden.

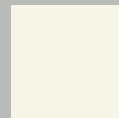

Corian® GW



Hemlock



Frassino  
Ash wood  
Esche



Lati

RIVESTIMENTI INTERNI . INSIDE CLADDING  
. INNENVERKLEIDUNG

Internamente i rivestimenti sono preincollati alla struttura delle pareti. Le finiture spaziano dal vetro lucido al marmo Bianco di Carrara al Corian® Glacier White.

Inside the claddings are pre-glued to the walls' structure. The finishes' range includes polished glass, marble Bianco di Carrara, Corian® Glacier White.

Auf der Innenseite werden die Verkleidungen auf die Wandstruktur aufgeklebt. Die Verkleidungspalette enthält poliertes Glas, Marmor Bianco di Carrara und Corian® Glacier White.

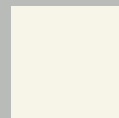

Corian® GW



Velvet Carrara



Grigio  
Gray  
Grau



Nero  
Black  
Schwarz

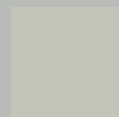

Corda



Tortora



Moka

## / TIPOLOGIE

## INGRESSO LATERALE . LATERAL ENTRANCE . SEITENEINGANG

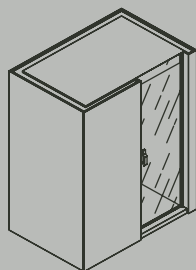

/ PLT01

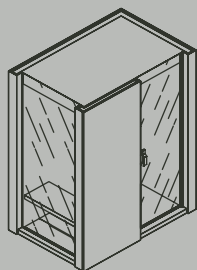

/ PLT02

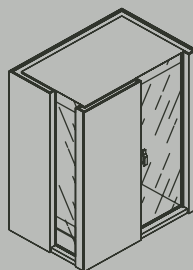

/ PLT03

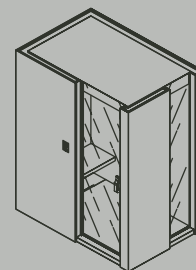

/ PLT04

Anta singola . Single door . Einzeltuer

-  
 120 x 100 cm  
 120 x 120 cm  
 150 x 120 cm  
 180 x 120 cm  
 210 x 120 cm  
 240 x 120 cm

Anta + vetro fisso . Door + fixed glass . Tuer + festes Glas

-  
 180 x 120 cm  
 210 x 120 cm  
 240 x 120 cm

Tipologia . Typologies . Typologien

-  
 Isola . freestanding . insel / PLT01 . PLT02 . PLT03 . PLT04  
 Angolo . corner . ecke / PLT01 . PLT02 . PLT03 . PLT04  
 Penisola . wall short side . halbinsel / PLT01  
 Parete . wall . wand / PLT01 . PLT02 . PLT03 . PLT04  
 Nicchia . niche . nische / PLT01

## INGRESSO CENTRALE . CENTRAL ENTRANCE . ZENTRALER EINGANG

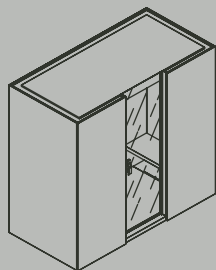

/ PCE01

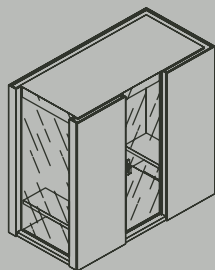

/ PCE02

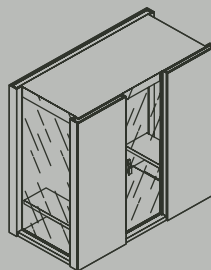

/ PCE03

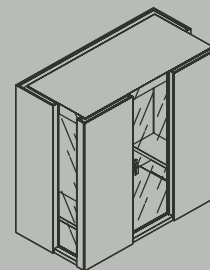

/ PCE04

Anta singola . Single door . Einzeltuer

-  
 180 x 120 cm  
 210 x 120 cm  
 240 x 120 cm

Anta + vetro fisso . Door + fixed glass . Tuer + festes Glas

-  
 210 x 120 cm  
 240 x 120 cm

Tipologia . Typologies . Typologien

-  
 Isola . freestanding . insel / PLT01 . PLT02 . PLT03 . PLT04  
 Angolo . corner . ecke / PLT01 . PLT02  
 Penisola . wall short side . halbinsel / PLT01  
 Parete . wall . wand / PLT01 . PLT02 . PLT03 . PLT04  
 Nicchia . niche . nische / PLT01

/ HIDDEN  
DESIGN . GIULIO GIANTURCO



/ HIDDEN









HIDDEN è un enigmatico contenitore disegnato da Giulio Gianurco che richiama elementi classici del mondo nautico o dei set da viaggio del passato. Aperto svela la sua vera identità: una funzionalissima area trucco con lavabo e piani di appoggio ribassati in Makril, rubinetto in acciaio inox 316 L, specchio con luce integrata, specchio ingranditore, cassetto porta oggetti, presa USB e corrente elettrica.

HIDDEN is an enigmatic box designed by Giulio Gianurco reminding the traditional elements of the nautical world and the trunks of yore. When open it reveals its true identity: a very functional make-up area with washbasin and lowered plans in Makril, taps in stainless steel 316L, mirror with integrated light, magnifying mirror, drawer and USB plug.

HIDDEN ist ein rätselhafter Waschtischunterschrank gezeichnet von Giulio Gianurco, der an die traditionellen Elemente der Schifffahrtswelt oder an die Ueberseekoffer der Vergangenheit erinnert. Falls geöffnet enthüllt seine Identität: ein funktioneller Waschtisch zum Schminken mit abgeflachter Anlage in Makril, Armaturen in Inox-Stahl 316L, Spiegel mit integriertem Beleuchtungssystem, Vergrößerungsspiegel, Schublade und USB Steckdose.



Richiuso HIDDEN diventa un originale e rigoroso volume in legno, di nuda essenzialità che ne consente l'integrazione in ogni tipo di ambiente.

-  
When it is closed HIDDEN becomes an original, rigorous and essential wooden box which can be integrated in any room.

-  
Falls geschlossen wird HIDDEN ein neuartiger Waschtisch aus Holz, der in allen Räumen integriert werden kann.

Il calore e l'eleganza della finitura in Hemlock termotrattato contrasta con la superficie morbida del lavabo in Makril e la nitidezza dell'acciaio inox di rubinetteria e meccanismo di apertura.

The warmth and the elegance of the Hemlock thermo-treated wood contrasts with the soft surface of the Makril washbasin and the polish of the stainless steel taps and of the opening mechanism.

Die Waerme und die Eleganz des thermo-behandelten Holzes Hemlock Ausfuehrung sind im Gegensatz zur weichen Oberflaeche des Beckens in Makril und zur polierter Ausfuehrung der Armaturen und des Oeffnungsmechanismus.

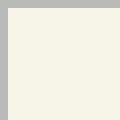

Makril



Hemlock



Frassino  
Ash wood  
Esche



Lati

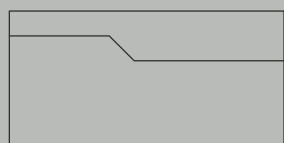
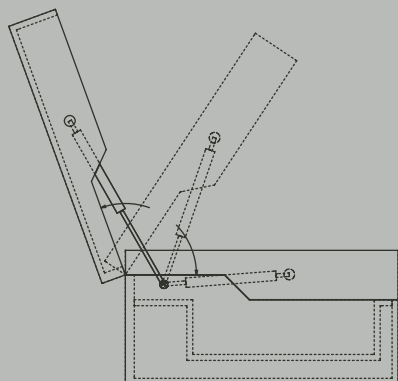
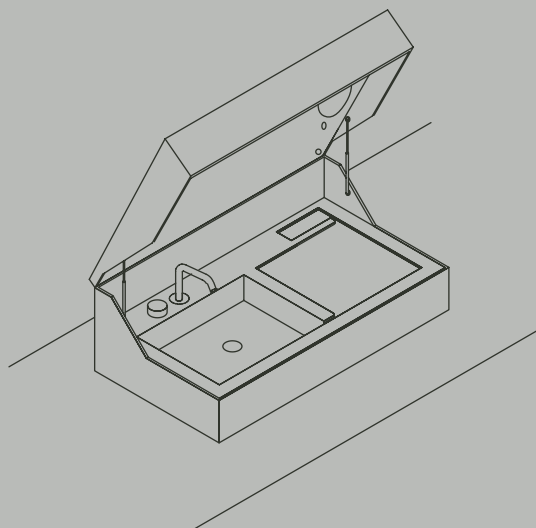

/ HIDDEN

L - 100 cm  
P - 55 cm  
H - 30 cm



/ HIDDEN

/ MAKRO SYSTEMS  
DESIGN . MAKRODESIGN





/ MAKRO SYSTEMS





/ MAKRO SYSTEMS

MAKRO SYSTEMS consente il superamento dei modelli convenzionali della stanza da bagno, offrendo nuove e inedite opportunità di progetto. MAKRO SYSTEMS nasce dall'integrazione di vasche, docce, hammam, lavabi, contenitori e specchi delle diverse collezioni: una vastissima gamma di composizioni dalla tecnologia celata e dalle finiture contemporanee, perfetta integrazione di estetica e funzionalità, per ambienti bagno anche di piccole dimensioni.

The MAKRO SYSTEMS program overcomes the traditional bathroom models and offers new and innovative project solutions. MAKRO SYSTEMS is the result of the integration of bathtubs, showers, steambaths, washbasins, cabinets and mirrors of our collection. It offers a wide range of combinations, characterized by hidden technology and contemporary finishes, which are the perfect integration of aesthetics and functionality also for smaller bathrooms.

Das Programm MAKRO SYSTEMS ueberschreitet die traditionelle Regel im Badezimmer und bietet neue Projektmoeglichkeiten an. MAKRO SYSTEMS ist das Ergebnis der Integration von Badewannen, Duschen, Dampfbadern, Waschbecken, Schraenken und Spiegeln der Kollektion, gekennzeichnet durch versteckter Technologie und zeitgenoessischen Ausfuehrungen, die perfekte Verbindung von Aesthetik und Funktionalitaet.

/ MAKRO SYSTEMS

Sistema vasca lavabo frontale.  
Vasca STYLE con rivestimento in vetro nell'inedito colore Indaco.  
Lavabo LOOP L e specchio  
DOUBLE FACE MIRROR.

Frontal bathtub-washbasin System  
STYLE bathtub clad in the new  
Indaco color. LOOP L washbasin  
and DOUBLE FACE MIRROR.

Frontales Badewanne-  
Waschbecken System.  
Badewanne STYLE in der neuen  
Farbe Indaco. Becken LOOP L und  
Spiegel DOUBLE FACE MIRROR.

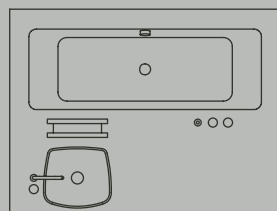
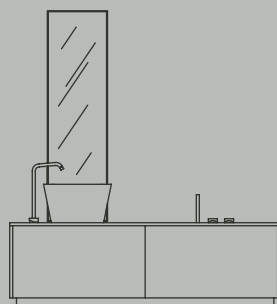
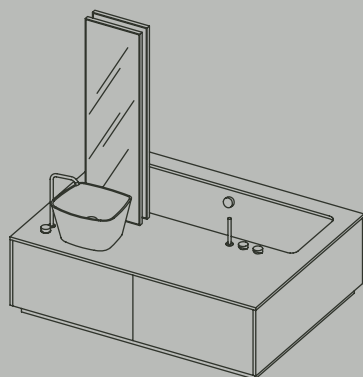

/ MAKRO SYSTEMS

L - 190 cm  
P - 160 cm  
H - 62 cm . 202 cm





/ MAKRO SYSTEMS

Attenzione e ricercatezza dei dettagli sono i tratti distintivi dell'intero programma MAKRO SYSTEMS.

-

Attention and detail care is one of the distinctive features of the whole MAKRO SYSTEMS program

-

Sorge und Suche nach Detail ist ein wichtiges Merkmal der ganzen Kollektion MAKRO SYSTEMS.





Composizione monocromatica Vasca-lavabo frontale. L'effetto caldo e materico della finitura ECOCEMENTO si contrappone alla nitida lucentezza dell' acciaio inox della rubinetteria OX e al bianco assoluto del lavabo in Makril.

Monochromatic bathtub-washbasin frontal composition. The warm effect of the ECO-CEMENT finish contrasts the polish of the OX stainless steel taps and the whiteness of the Makril washbasin.

Einfarbiges frontales Badewanne-Waschtisch System. Die Waerme der ZEMENT VERKLEIDUNG ist im Gegensatz zur polierten Ausfuehrung der Armaturen in OX Inox-Stahl und zur weissen Farbe des Beckens in Makril.



/ MAKRO SYSTEMS

- Vasca STYLE con airpool, mensola WING in finitura laccata + lavabo LOOP XL, rubinetteria OX in acciaio inox e specchio bifacciale AIR con illuminazione.

- STYLE bathtub with airpool, WING console in laquered wood finish + LOOP XL washbasin, OX taps in stainless steel and double-face mirror AIR with lighting.

- Badewanne STYLE mit Airpool, WING Konsole in lackierter Ausfuehrung + Waschbecken LOOP XL, Armaturen OX aus Inox-Stahl und doppelseitiger Spiegel AIR mit Beleuchtung.

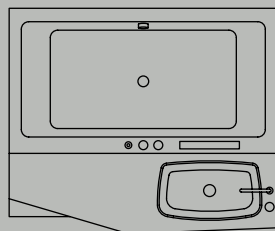
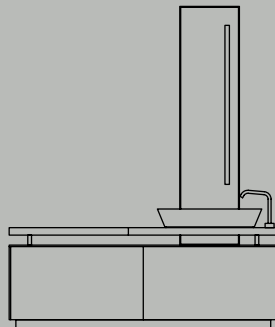
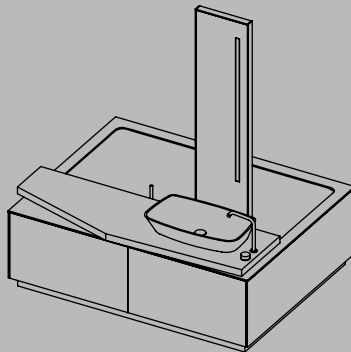

/ MAKRO SYSTEMS

- L - 190 cm  
P - 160 cm  
H - 71 cm . 202 cm







SISTEMA vasca lavabo lineare OPEN in Bianco di Carrara levigato fine dall'effetto morbido. La classicità del marmo si fonde con i materiali della modernità: Solid Surface per il lavabo LOOP, acciaio inox di rubinetteria e specchio e grigio grafite per la laccatura di contenitori e zoccolo.

Bathtub-washbasin OPEN linear SYSTEM in marble Bianco di Carrara with soft fine grain. The classical nature of the marble blends in with the modernity of the Solid Surface of the LOOP washbasin, with the stainless steel of the taps and of the mirror and with the lacquered finish graphite grey of the racks and of the base.

Lineares SYSTEM Badewanne-Waschtisch OPEN in Marmor Bianco di Carrara fein poliert und weich. Die Klassik vom Marmor schliesst sich mit der Modernität zusammen: Solid Surface fuer das LOOP Becken, Inox-Stahl fuer die Armaturen und den Spiegel, graphit-grau fuer die Lackierung des offenen Fachs und des Zockels.





/ MAKRO SYSTEMS

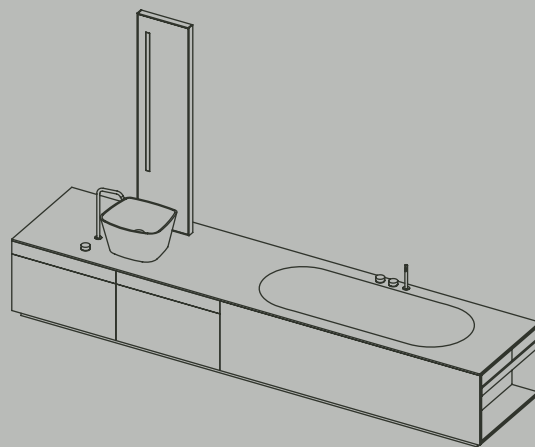

- Sistema vasca lavabo lineare.  
Vasca LOOK con rivestimento in marmo Bianco di Carrara.  
Lavabo LOOP L, rubinetteria OX in acciaio inox e specchio AIR con illuminazione incorporata.

- LOOK bathtub clad in marble Bianco di Carrara, LOOP L washbasin, OX taps in stainless steel and AIR mirror with integrated lighting system.

- Badewanne LOOK in Marmor Bianco di Carrara, Becken LOOP L, Armaturen OX aus Inox-Stahl und doppelseitiger Spiegel AIR mit Beleuchtung.

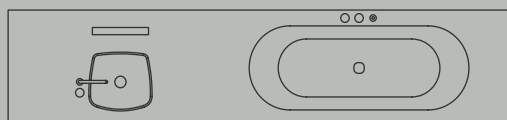
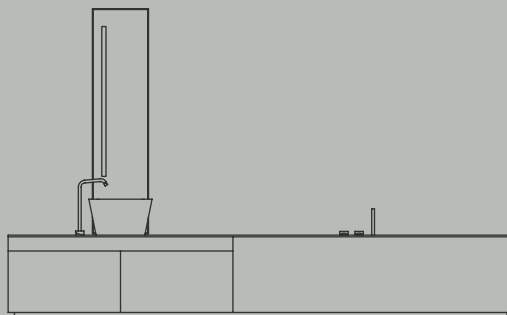

/ MAKRO SYSTEMS

-  
L - 360 cm  
P - 80 cm  
H - 62 cm . 202 cm





Composizione vasca-lavabo di  
misure contenute adatta per  
bagni di piccola dimensione.  
Finitura Makril.

-

Smaller bathtub-washbasin  
composition suitable for narrow  
bathrooms. Makril finish.

-

Komposition Badewanne-  
Waschbecken geeignet fuer  
kleinere Badezimmer. Makril  
Ausfuehrung.



/ MAKRO SYSTEMS

/ MAKRO SYSTEMS

- Vasca LOOK con rivestimento Makril.  
Lavabo LOOP L, rubinetteria OX in  
acciaio inox e specchio AIR con  
illuminazione incorporata.

- LOOK bathtub clad in Makril, LOOP L  
washbasin, OX taps in stainless steel and  
AIR mirror with integrated lighting system.

- LOOK Badewanne mit Makril  
Verkleidung, Waschbecken LOOP L,  
Armaturen OX aus Inox-Stahl und Spiegel  
AIR mit integriertem Beleuchtungssystem.

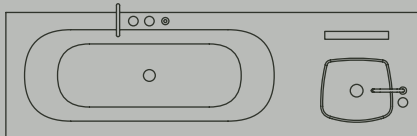
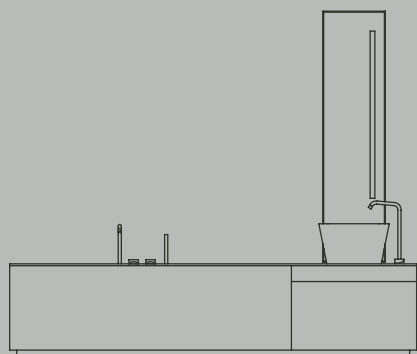
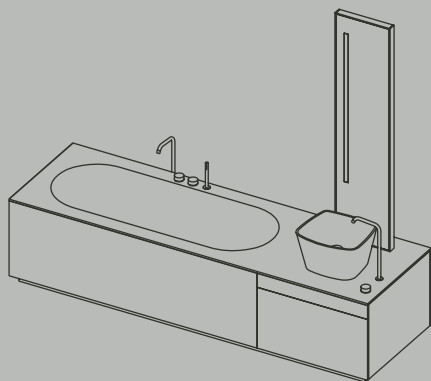

/ MAKRO SYSTEMS

-  
L - 260 cm  
P - 80 cm  
H - 62 cm . 202 cm







/ MAKRO SYSTEMS

/ LOFT



/ LOFT

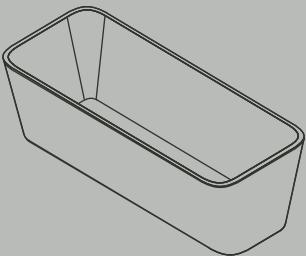

/ LOFT  
-  
L - 170 cm  
P - 70 cm  
H - 50 cm



Classicità e contemporaneità sono i tratti caratterizzanti la vasca LOFT, proposta in Makril bianco assoluto e posizionabile a centro stanza o in appoggio a parete.

Classical and contemporaneous, LOFT is available in Makril absolute white and can be installed both freestanding and against the wall.

Klassik und zeitgenössisch, ist LOFT in Makril weiss vorhanden. Die Badewanne kann freistehend oder an der Wand installiert werden.



/ LOFT

/ SUITE OPEN  
DESIGN . MAKRODESIGN



/ SUITE OPEN

Contrasti misurati ed equilibrio di materiali per la vasca SUITE OPEN in Makril bianco matt e per il contenitore a giorno in legno termotrattato Lati.

Measured contrasts and balance in the materials for the SUITE OPEN bathtub in white Makril and for the open rack in thermo-treated wood Lati.

Ueberlegte Gegensatzte und Gleichgewicht der Materialien fuer die Badewanne SUITE OPEN in weiss Makril und fuer das offene Fach in thermo-behandeltem Holz Lati.





/ SUITE OPEN

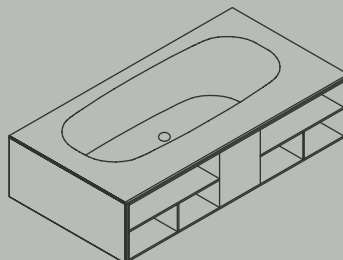

/ SUITE OPEN

-  
L - 200 cm  
P - 104 cm  
H - 50 cm

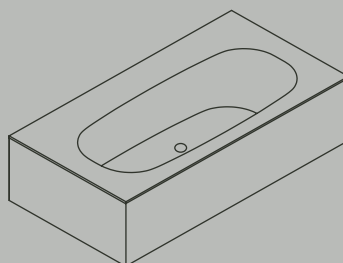

/ SUITE

-  
L . P - 180x80 cm  
L . P - 190x90 cm  
L . P - 200x100 cm  
H - 50 cm

/ MY STYLE . CORIAN® DEEP NOCTURNE  
DESIGN . MAKRODESIGN



/ MY STYLE . CORIAN® DEEP NOCTURNE



/ MY STYLE . CORIAN® DEEP NOCTURNE

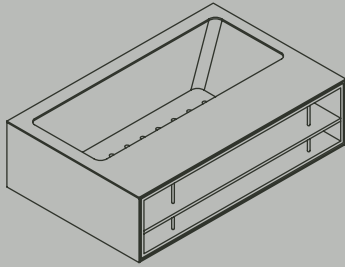

/ MEDIUM

-

L - 190 cm

P - 115 cm

H - 50 cm

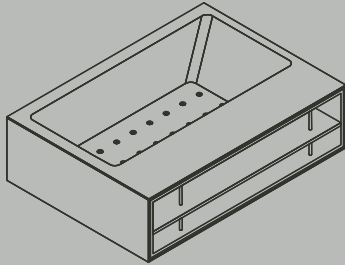

/ LARGE

-

L - 190 cm

P - 130 cm

H - 50 cm



Versione total black per la vasca MY STYLE rivestita in Corian® Deep Nocturne con contenitore a giorno e rubinetteria in acciaio inox.

-

Total black version for the MY STYLE bathtub clad in Corian® Deep Nocturne with open rack and taps in stainless steel.

-

Version total black fuer die Badewanne MY STYLE verkleidet in Corian® Deep Nocturne, mit offenem Fach und Armaturen in Inox-Stahl.



/ MY STYLE . CORIAN® DEEP NOCTURNE

/ LOOK . CORIAN® DEEP NOCTURNE  
DESIGN . MAKRODESIGN

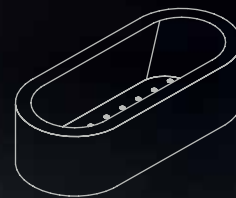

/ LOOK . CORIAN® DN

-  
L - 180 cm  
P - 80 cm  
H - 50 cm



/ LOOK . CORIAN® DEEP NOCTURNE

/ TENDER  
DESIGN . MARCO TAIETTA



/ TENDER



/ TENDER 60

-  
L - 60 cm  
P - 48 cm  
H - 50 cm

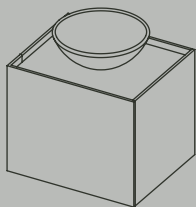

/ TENDER 90

-  
L - 90 cm  
P - 48 cm  
H - 50 cm

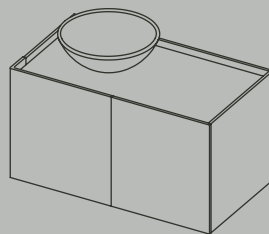





TENDER è un mobile lavabo dalle dimensioni contenute, caratterizzato dal particolare risvolto dell'anta e dalla sua sporgenza rispetto al filo top che ne consente l'apertura. Il lavabo è personalizzabile fra diversi modelli mentre il top è declinabile nei colori di gamma, laccato opaco.

- TENDER is a small vanity which stands out thanks to the lip of its door protruding from the edge of the vanity top. It can be combined with different washbasins and the top is available in a wide range of matt colors.

- TENDER ist ein kompakter Waschtisch gekennzeichnet durch die Sonderform der Tuer, die als Handgriff gilt. Er ist mit verschiedenen Becken kombinierbar und seine Abdeckung ist in den zahlreichen matten Farben der Standard Palette erhaltlich.



/ TENDER

/ FLAT + UP ECOCEMENTO  
DESIGN . MAKRODESIGN



/ FIAT + UP ECOCEMENTO

/ UP ECOCEMENTO + ESSENTIAL

-  
Composizione con piano UP e contenitore ESSENTIAL,  
tutto ECOCEMENTO Antracite. Lavabo semincasso CUP in  
Corian® Deep Nocturne.

-  
Composition with console UP and cabinet ESSENTIAL,  
all in Anthracite ECO-CEMENT. Half-recessed washbasin  
CUP in Corian® Deep Nocturne.

-  
Komposition von Waschtischanlage UP und Schrank  
ESSENTIAL in ZEMENT Anthrazit Ausführung, halb-  
eingebautem Becken CUP in Corian® Deep Nocturne.



/ ECOCEMENTO ANTRACITE

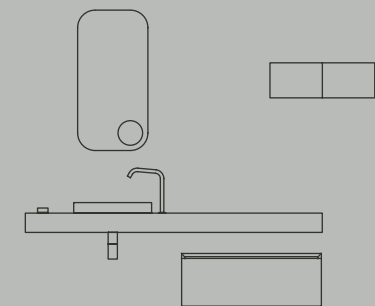

/ UP ECOCEMENTO + ESSENTIAL

- FLAT

-  
L - min 80 . max 240 cm . e a misura  
. made-to-measure . massgefertigt  
P - 48 . 55 cm  
H - 11 cm

- ESSENTIAL

-  
L - 80 cm  
P - 48 cm  
H - 30 cm

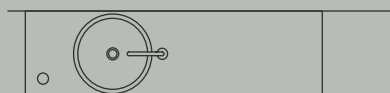

/ ECOCEMENTO GRIGIO

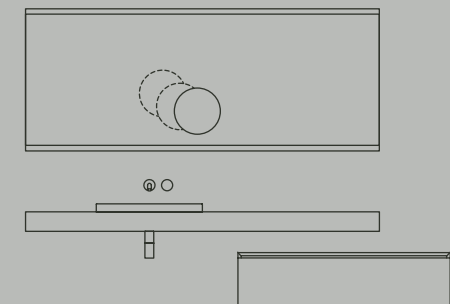

/ UP ECOCEMENTO + ESSENTIAL

- FLAT

-  
L - min 80 . max 240 cm . e a misura  
. made-to-measure . massgefertigt  
P - 48 . 55 cm  
H - 11 cm

- ESSENTIAL

-  
L - 80 . 120 . 140 cm  
P - 48 cm  
H - 30 cm



/ ECOCEMENTO MOKA

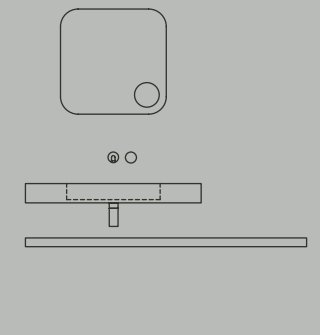

/ FLAT ECOCEMENTO + MINIMAL

- FLAT

-  
L - min 80 . max 240 cm e a misura .  
. made-to-measure . massgefertigt  
P - 48 . 55 cm  
H - 11 cm

- MINIMAL

-  
L - min 80 . max 240 cm  
P - 48 cm  
H - 6 cm

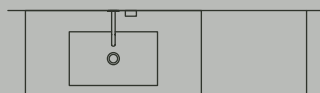

/ ECOCEMENTO



Bianco  
White  
Weiss



Grigio cemento  
Cement grey  
Zement grau

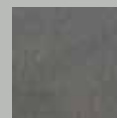

Antracite  
Anthracite  
Anthrazit



Beige

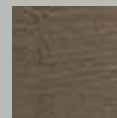

Moka

/ UP ECOCEMENTO + ESSENTIAL

ECOCEMENTO Grigio è la finitura della composizione con piano FLAT a semincasso e contenitore ESSENTIAL in essenza Lati. Lavabo semincasso ARTIC e specchio EGO.

Composition with FLAT console in Grey ECO-CEMENT, half-recessed washbasin ARTIC, ESSENTIAL cabinet in Lati and EGO mirror.

Komposition in ZEMENT Verkleidung Grau mit Waschtischanlage FLAT, halb-eingebautem Becken ARTIC, ESSENTIAL Schrank in Lati Ausfuehrung und Spiegel EGO.





/ FIAT + UP ECOCEMENTO







/ FLAT + UP ECOCEMENTO

/ FLAT ECOCEMENTO + MINIMAL

-  
La matericità dell'ECOCEMENTO color Moka per il piano FLAT con lavabo integrato e legno termotrattato Lati per la mensola a misura MINIMAL.

-  
The distinctive texture of ECO-CEMENT Moka color for the console FLAT with integrated washbasin and thermo-treated wood Lati for the made-to-measure shelf MINIMAL.

-  
Gegenstaendlichkeit der ZEMENT Verkleidung Moka fuer die Waschtischanlage FLAT und thermo-behandeltes Holz Lati fuer die massgefertigte Konsole MINIMAL.

/ WAVE . ECOCEMENTO  
DESIGN . MAKRODESIGN



/ WAVE . ECOCEMENTO

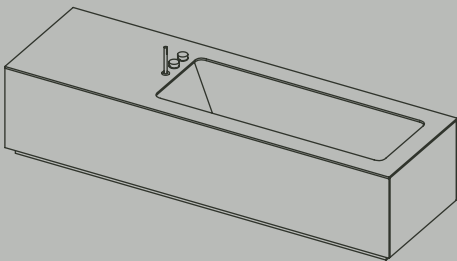

/ WAVE . ECOCEMENTO

-  
L - 240 cm a misura . made-to-measure . massgefertigt  
P - 80 cm  
H - 50 cm

-  
Un forte richiamo alla modernità per la vasca WAVE  
asimmetrica in ECOCEMENTO grigio con rubinetteria da bordo  
vasca in acciaio inox OX.

-  
Strong reference to modernity for the WAVE asymmetric bathtub  
in grey ECO-CEMENT with OX countertop taps in stainless steel.

-  
Hinweis auf Modernität fuer die asymmetrische Badewanne  
WAVE mit grauer ZEMENT VERKLEIDUNG, ausgestattet mit  
Waschtisch Armaturen OX aus Inox-Stahl.





/ WAVE . ECOCEMENTO

/ SHADE  
DESIGN . MARCO TAIETTA





/ SHADE



/ SHADE . Tessuti  
 . Textile . Stoff  
 . Kvadrat Gloss 3



112  
 Grigio chiaro  
 Light gray  
 Hellgrau



172  
 Antracite  
 Anthracite  
 Anthrazit



202  
 Beige



663  
 Rosa  
 Pink  
 Rosafarbig



743  
 Blu  
 Blue  
 Blau

/ SHADE . Tessuti  
 . Textile . Stoff  
 . Rubelli Punteggiato



3005-05  
 Bronzo

/ SHADE . Telaio  
 . Frames . Rahmen



Bianco  
 White  
 Weiss



Grigio grafite  
 Graphite gray  
 Schwarz



Bronzo ottone  
 Bronze brass  
 Bronze

SHADE è una innovativa quinta mobile, originale rilettura del classico paravento. E' una soluzione ideale per la partizione di piccoli spazi privati legati all'ambiente bagno e wellness ma il suo impiego puo' spaziare in altri luoghi del vivere contemporaneo. I moduli, accessoriabili con specchi, tasche portaoggetti e portasalviette, sono aggregabili senza fine e possono essere rivestiti con tessuti Kvadrat e in pelle naturale. Proposta speciale è il rivestimento "Punteggiato" di Rubelli, riproposizione contemporanea di un tessuto originale disegnato da Gio' Ponti nel 1934.

SHADE is an innovative and modern reinterperation of the traditional folding screen. It represents the ideal solution for the organization of small private spaces related to the bathroom and wellness environment, but can be used at the same time in other rooms as well. The modules can be equipped with mirrors, object holders pockets and towel holders, and can be combined together in infinite solutions. Shade is available in fabric Kvadrat and in natural leather, but also in the special cladding "Punteggiato" by Rubelli, which is a contemporary reinterpretation of the original texture designed by Giò Ponti in 1934.

SHADE ist ein erneuerndes Paravent, gelesen unter einem modernen Gesichtspunk. Es handelt sich um die vollkommene Loesung fuer die Organisation der Raeume im Bad- und Wellness Bereich, die aber auch in anderen Zimmern verwendet werden kann. Die Modulen koennen mit Spiegeln, Objekttraeger Taschen und Handtuchhaltern ausgestattet werden, die unendlich zusammen zu kombinieren sind, und sind in Stoff Kvadrat oder in natuerlichem Leder erhaltlich. Ein Sonderstoff ist der "Punteggiato" von Rubelli, eine zeitgenoessische Interpretation des originalen Stoffs gezeichnet von Giò Ponti in 1934.

SHADE con telaio bronzo-ottone e tessuto "Punteggiato" bronzo del 1934 di Gio' Ponti per Rubelli. Composizione a 4 moduli di cui uno a specchio.

-  
SHADE with bronze-copper frame and bronze "Punteggiato" embossed spotted fabric from 1934 by Gio' Ponti for Rubelli. Composition with 4 modules, one of which is mirrored.

-  
SHADE mit Rahmen Bronze-Messing und Stoff "Punteggiato" in Farbe Bronze von Gio' Ponti fuer Rubelli, 1934. Kombination von 3 Stoff-Modulen und 1 Spiegel-Modul.



/ SHADE

/ SHADE

-  
Modulo singolo . Single frame . Einzel-Modul

-  
L- 40 cm  
P- 2 cm  
H- 200 cm

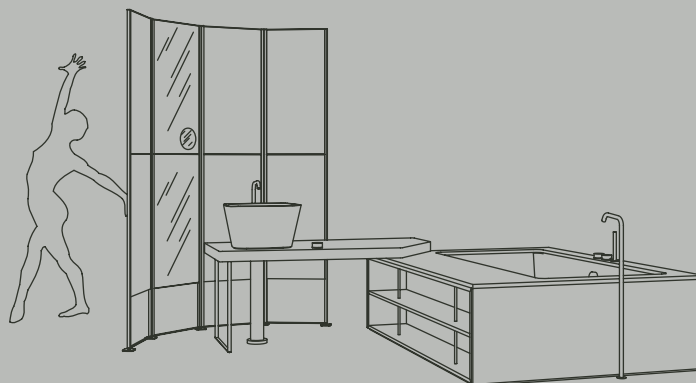



/ SHADE\_L . Pelle . Leather . Leder



Grigio fumo  
Smoky gray  
Rauchgrauem



Rosso bruno  
Red brown  
Rot braun

La pelle mezzo fiore - eccellenza italiana - è proposta di serie in 2 cromie, ma la personalizzazione è massima potendo scegliere fra una gamma cromatica di 48 colori.

The medium grain leather - Italian excellence - is available in 2 standard colors, but on request it is also possible to choose among 48 colors offering a wide range of customization opportunities.

Das Narbenleder - italienisches Spitzenleder - ist in 2 standard Farben erhältlich, aber auf Anfrage ist eine Palette von 48 Farben vorhanden.

/ SHADE . Telaio . Frame . Rahmen



Grigio grafite  
Graphite gray  
Graphitgrau



Rosso bruno  
Red brown  
Rot braun

/ SHADE\_L

- Modulo singolo . Single frame . Einzelbild

- L - 40 cm  
P - 2 cm  
H - 200 cm

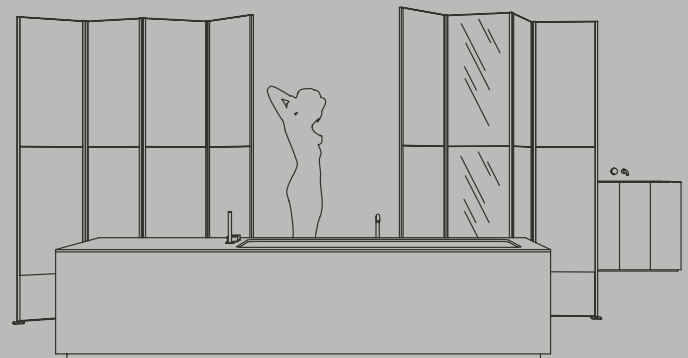
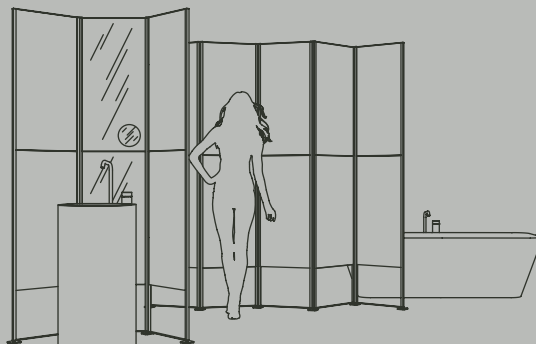

SHADE\_L in pelle colore Grigio fumo accessoriato con portasalviette e tasche portaoggetti in cuoio e pelle. Modulo centrale interamente a specchio con integrata lente ingrandente.

SHADE\_L in smoky grey leather equipped with towel holder and pocket object holder in hide and leather. Central mirrored module with integrated magnifying lens.

SHADE\_L in Rauchgrauem Leder ausgestattet mit Handtuchhalter und Objektträger Tasche in Leder und Feinleder. Zentrales Spiegel-Modul mit Vergrößerungslinse.



# / MATERIAL TABLE

DESIGN . MARCO TAIETTA





/ MATERIAL TABLE





MATERIAL TABLE è un set di piccoli tavoli di servizio coordinati per finiture e materiali alle diverse collezioni Makro. Il telaio in metallo verniciato è integrato da un piano in Corian® Glacier White, legno termotrattato, Marmo di Carrara o Pietra lavica di Sicilia.

MATERIAL TABLE is a set of small tables combined in finishes and materials with the different Makro collections. The varnished metal frame is integrated by a top in Corian® Glacier White, thermo-treated wood, Carrara marble or Sicily Lava stone.

MATERIAL TABLE ist ein Set von kleinen Tischen kombiniert in Ausfuehrungen und Materialien zur Makro Produktpalette. Das lackierte Metall-Rahmen ist ausgestattet mit einer Abdeckung in Corian® Glacier White, thermo-behandeltem Holz, Carrara Marmor oder Lavastein aus Sizilien.

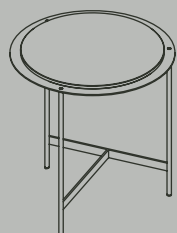

/ MATERIAL TABLE high

Ø - 45 cm  
H - 45 cm

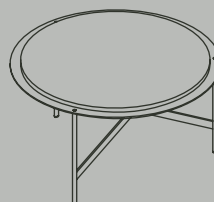

/ MATERIAL TABLE big

Ø - 60 cm  
H - 30 cm

Materiali per top tavolini . Tops materials available . Abdeckung Ausfuehrung

Telaio . Frame . Rahmen



Hemlock



Frassino  
Ash wood  
Esche

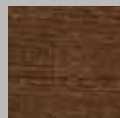

Lati

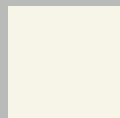

Corian® GW



Velvet Carrara  
Carrara marble  
Carrara Marmor

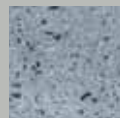

Pietra lavica  
Lava stone  
Lavastein



Bianco opaco  
Matt white  
Matt weiss



Nero opaco  
Matt Black  
Matt Schwarz



/ MATERIAL TABLE



/ EGO  
DESIGN . KING & ROSELLI



/ EGO





Specchio intrigante e ironico dalle forme pulite e rigorose, EGO è concepito come una lavagna magnetica sulla cui superficie è possibile applicare oggetti di uso quotidiano da far scorrere a piacere come in una sorta di gioco. Accessori liberi che scivolando diventano un tutt'uno con la superficie specchiante.

EGO is an intriguing and ironic mirror, with a simple and rigorous design, conceived like a magnetic blackboard where it is possible to apply daily objects, which can freely slide like in a sort of game. Free sliding accessories which become all in one with the mirrored surface.

EGO ist ein intriganter und ironischer Spiegel mit reiner und rigoroser Form, der als magnetischer Tafel gedacht wurde. Auf seine Oberfläche koennen Objekte fuer den Alltagsgebrauch bewegt werden. Es handelt sich um Zubehoere, die eine Einheit mit der gespiegelten Oberfläche werden.

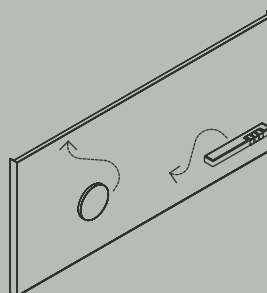

/ EGO BASE

-  
L - 80 . 120 . 160 . 180 . 200 . 240 cm  
P - 5,5 cm  
H - 80 cm

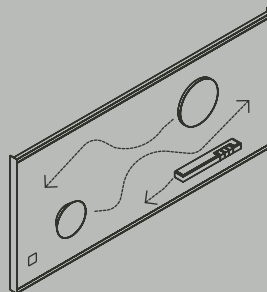

/ EGO PLUS

-  
L - 80 . 120 . 160 . 180 . 200 . 240 cm  
P - 5,5 cm  
H - 80 cm







/OX/

RUBINETTERIA PER LAVABO . WASHBASIN TAPS . WASCHTISCH ARMATUREN



Miscelatori e bocche erogazione da piano . Countertop mixers and spouts .  
Waschtisch Mischer und Duesen



/ OX - WB\_01



/ OX - WB\_02

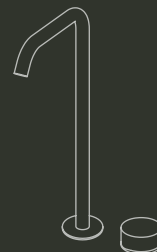

/ OX - WB\_03



Miscelatori da parete e bocche erogazione da piano . Wall mixer and  
countertop spouts . Wand Mischer und Waschtisch Duesen



/ OX - WB\_04

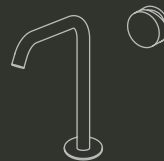

/ OX - WB\_05

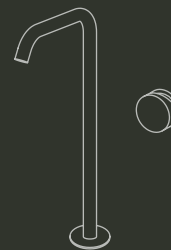

/ OX - WB\_06

OX è una rubinetteria per ambienti bagno e wellness in acciaio inox AISI 316L. Il disegno puro ed essenziale della manopola di comando, personalizzabile in 4 finiture, è identificativo dell'intero programma. Il suo abbinamento con le diverse bocche di erogazione ne esalta le proporzioni e il preciso segno grafico.

OX is a collection of taps in stainless steel AISI 316L for the bathroom and wellness environment. The pure and essential design of the mixer, customizable in 4 finishes, identifies the whole program and its combination to the different spouts highlights its proportions and its precise graphic sign.

OX ist eine Kollektion von Armaturen aus Inox-Stahl AISI 316L fuer den Badezimmer- und Wellness Bereich. Das pure und wesentliche Design vom Mischer, personalisierbar in 4 Ausfuehrungen, kennzeichnet die ganze Serie und ist mit verschiedenen Duesen kombiniert.

RUBINETTERIA PER LAVABO . WASHBASIN TAPS . WASCHTISCH ARMATUREN



Miscelatori e bocche erogazione da parete . Wall mixers and spouts . Wand-Mischer und Duesen



/ OX - WB\_07



/ OX - WB\_08



Miscelatori da piano e bocche erogazione da parete . Countertop mixers and wall spouts . Waschtisch-Mischer und Wand-Duesen



/ OX - WB\_09



/ OX - WB\_10

/ OX

Miscelatori e bocche lavabo . Washbasin spouts and mixer . Waschtisch-Mischer und Duesen

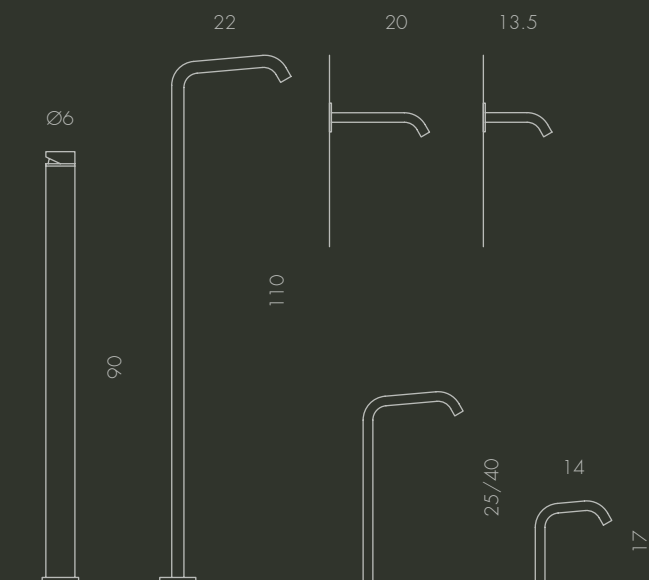

Miscelatori e bocche vasca . Bathtube spouts and mixer . Badewanne Mischer und Duesen

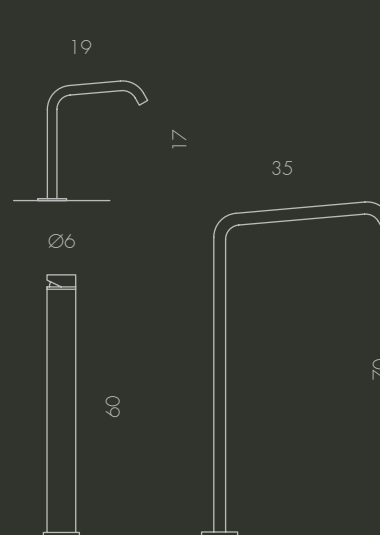

Doccini . Handshower . Handbrause

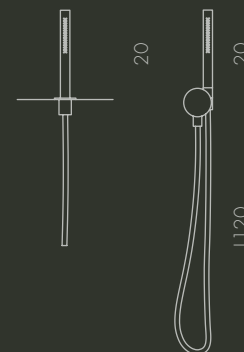

Bocca bidet . Bidet spout . Bidet Duese



RUBINETTERIA PER LAVABO . WASHBASIN TAPS . WASCHTISCH ARMATUREN



Bocca da terra . Floorstanding spout . Freistehende Duese

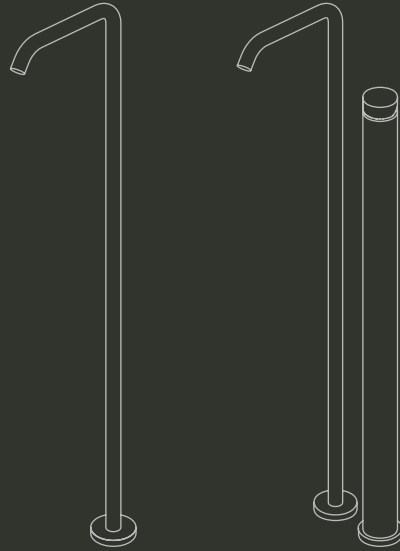

/ OX - WB\_11

/ OX - WB\_12

RUBINETTERIA BIDET . BIDET TAPS . BIDET ARMATUREN

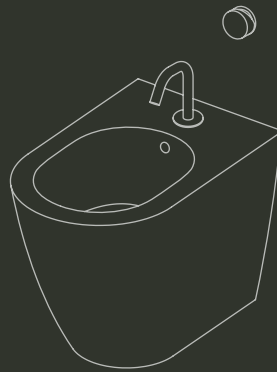

/ OX - BD\_01

MISCELATORI DOCCIA . SHOWER TAPS . DUSCHE ARMATUREN



Miscelatori e doccia a parete . Wall mounted mixers and handshower . Wand-Mischer und Handbrause

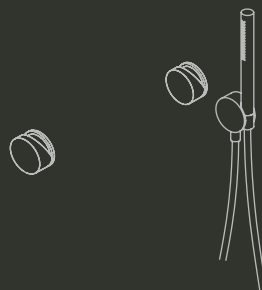

/ OX - SH\_01

/ OX - SH\_02

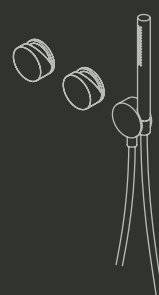

/ OX - SH\_03



Acciaio lucido  
Polished steel  
Polierter Stahl



Acciaio satinato  
Satinated steel  
Satinierter Stahl



Bianco  
White  
Weiss



Grigio  
Gray  
Grau

Miscelatore da parete e da piano. Manopola, dimensioni: Ø - 60 / H - 30mm. Finiture: satinata, lucida e verniciata. Miscelatore da pavimento manopola. Dimensioni: Ø - 60 / per lavabo H - 85mm / per vasca - H - 55mm. Finiture: satinata, lucida. Cartuccia con riduttore di portata regolabile, rimovibile e sistema antirumore.

Countertop and wall mounted mixer knob. Dimensions: Ø - 60 / H 30mm. Satined, polished, varnished finish. Floorstanding mixer knob. Dimensions: Ø - 60 / for washbasin H 85mm / for bathtub H - 55mm. Satined, polished finish. Cartridge with removable flow limiter device and antinoise system

Waschtisch- und Wand-Mischer. Dim. D.60 / H-30 mm. Ausführungen: satiniert, poliert und lackiert. Bodenstehender Mischer. Dim. D.60 / fuer Becken H 85 mm / fuer Badewanne - H 55mm. Ausführungen: satiniert, poliert. Kartusche mit regulierbarem und entfernbarem Durchflussmesser und Laermschutzsystem

RUBINETTERIA PER VASCA . BATHTUB TAPS . WANNEN-ARMATUREN



Miscelatori da bordo vasca . Washbasin countertop mixers .  
Wannen-Mischer



/ OX - BT\_01

/ OX - BT\_02

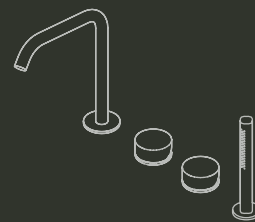

/ OX - BT\_03



Miscelatori da parete . Wall mixers . Wand Mischer

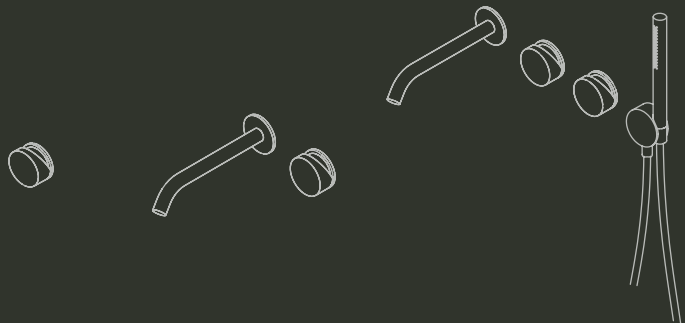

/ OX - BT\_04

/ OX - BT\_05

/ OX - BT\_06

RUBINETTERIA PER VASCA . BATHTUB TAPS . WANNEN-ARMATUREN



Miscelatori da bordo vasca con piastra . Bathtub countertop mixers with plate  
. Wannenrand-Mischer mit Platte

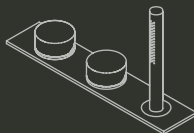

/ OX - BT\_02P

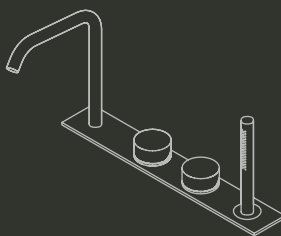

/ OX - BT\_03P



Bocca di erogazione e miscelatore da pavimento . Floor spout and mixer  
. Bodenstehende Duese und mischer

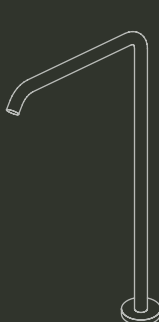

/ OX - BT\_07

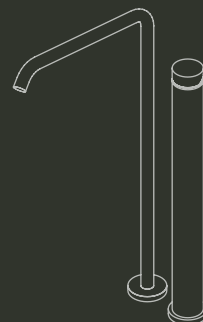

/ OX - BT\_08

/ OX /





SOFFIONE A PARETE . WALL MOUNTED SHOWER HEAD . WAND KOPFBRAUSE

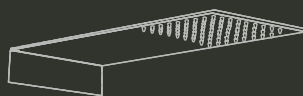

SOFFIONE 01

-  
L - 20 cm  
P - 45 cm  
H - 8 cm

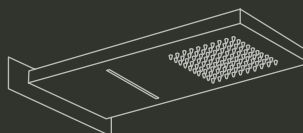

SOFFIONE 02

-  
L - 26 cm  
P - 55 cm  
H - 9 cm

SOFFIONI DOCCIA CON BRACCIO PARETE . SHOWER HEAD WITH WALL OR CEILING SHOWER ARM . KOPFBRAUSE MIT WANDBRAUSEARM

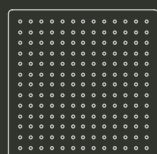

SOFFIONE 03

-  
L - 30 . 40 . 50 cm  
P - 30 . 40 . 50 cm

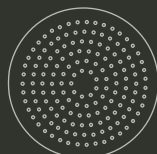

SOFFIONE 03

-  
Ø - 20 . 30 . 40 cm

Braccio a parete . Wall shower arm  
. Wandbrausearm

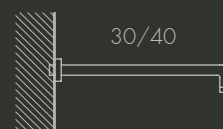

Braccio raggiato . Rounded arm . runder Wandbrausearm

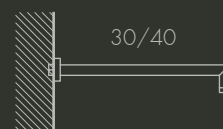

Angolo squadrato . Arm with squared corner  
. Decken-Kopfbrausearm

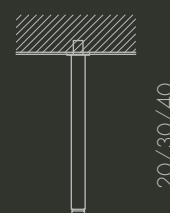

Braccio a soffitto . Ceiling shower arm  
. Decken-Kopfbrausearm

SOFFIONI A INCASSO CON E SENZA CROMOTERAPIA . BUILT IN SHOWER HEAD WITH AND WITHOUT COLOUR THERAPY . EINGEBaute KOPFBRAUSE MIT UND OHNE FARBTHERAPIE

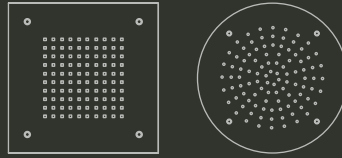

Soffione quadrato e rotondo . Square and round shower head  
. Viereckige und runde Kopfbrause

-  
L - 30 . 38 . 50 cm  
P - 30 . 38 . 50 cm

-  
Ø - 38 cm

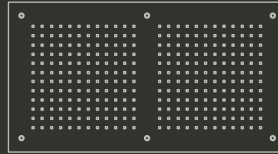

Soffione rettangolare . Rectangular shower head  
. Rechteckige Kopfbrause

-  
L - 70 cm  
P - 38 cm

SOFFIONI A INCASSO CON LAMA CASCATA . BUILT IN SHOWER HEAD WITH WATERFALL BLADE . EINGEBaute KOPFBRAUSE MIT SCHWALLAUSLAUF

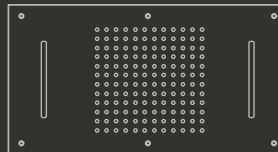

Soffione rettangolare . Rectangular shower head . Rechteckige Kopfbrause

-  
L - 70 cm  
P - 38 cm

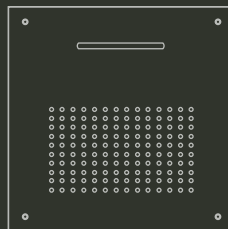

Soffione quadrato . Square shower head . Viereckige Kopfbrause

-  
L - 50 cm  
P - 50 cm

SOFFIONI A INCASSO IN CORIAN® . BUILT IN SHOWER HEAD IN CORIAN® . EINGEBAUTE KOPFBRAUSE IN CORIAN®

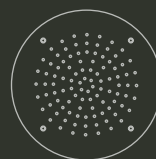
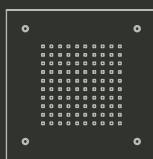

Soffione quadrato e rotondo in Corian® GW . Square and round shower head in Corian® GW . Viereckige und runde Kopfbrause in Corian® GW

L - 30 . 40 . 50 cm

P - 30 . 40 . 50 cm

Ø - 25 . 30

I soffioni - in acciaio inox satinato, inox lucido e Corian® GW, sono proposti in versione solo doccia o con integrazione di cromoterapia e cascata a lama singola o doppia. Possono essere utilizzati singolarmente o in abbinamento alla rubinetteria OX, alle docce e hammam in collezione.

The shower heads - in satinated or polished stainless steel and in Corian® GW, are available in the version only shower or with integrated color therapy and single or double waterfall blade. They can be used singularly or combined with the OX taps, the showers and the steambaths of the collection.

Die Kopfbrausen, in Inox-Stahl satiniert, poliert und Corian® GW, sind erhältlich in der Version nur Dusche oder koennen mit Farbtherapie und Wasserfall Funktion mit einem oder doppeltem Schwallauslauf ausgestattet werden. Sie koennen sowohl allein als auch mit den OX Armaturen, den Duschen und Dampfbaedern der Kollektion verwendet werden.





/ TYPE COLLECTION

/ T103. STOOL



/ T102 . ET.TABLE



/ T101 . LT.TABLE



/ T100 . Mensola sospesa  
. Suspended side table  
. Wandhaengendes Regal

/ T107 . Vassoio rettangolare . Rectangular rack  
Rechteckiges Tablett

/ T106 . Vassoio quadro . Square rack  
Viereckiges Tablett



/ T104 . BRIDGE



/ T112 . Set scopino . Set toilet brush  
 . Set Toilettenbuerste



/ T113 . Scopino . Toilet brush  
 . Toilettenbuerste



/ T111 . Porta carta . Toilet roll  
 . Toilettenpapierhalter



TYPE COLLECTION è una collezione di accessori per il bagno dal tratto elegante il cui concept rimanda al mondo degli origami. Le sottili lastre di alluminio assumono forme inaspettate, dal design essenziale e lineare, in grado di adattarsi a piani lavabo, vasche o docce sottoforma di mensole, piani d'appoggio, vassoi o sedute.

TYPE COLLECTION is a collection of bathroom accessories which displays an elegant trait reminding the origami world. The thin aluminum belts take unexpected shapes with an essential and linear design, adapting to consoles, bathtubs or showers in the form of shelves, trays, racks or stools.

TYPE COLLECTION ist eine elegante Kollektion von Zubehoeren fuer das Badezimmer, die an die Origami Welt erinnert. Die duennen Aluminium Platten nehmen unerwartete Gestaelte an, gekennzeichnet durch ein lineares und wesentliches Design, die als Konsole, Tablette oder Schemel zu Waschtischen, Badewannen oder Duschen gut passen.

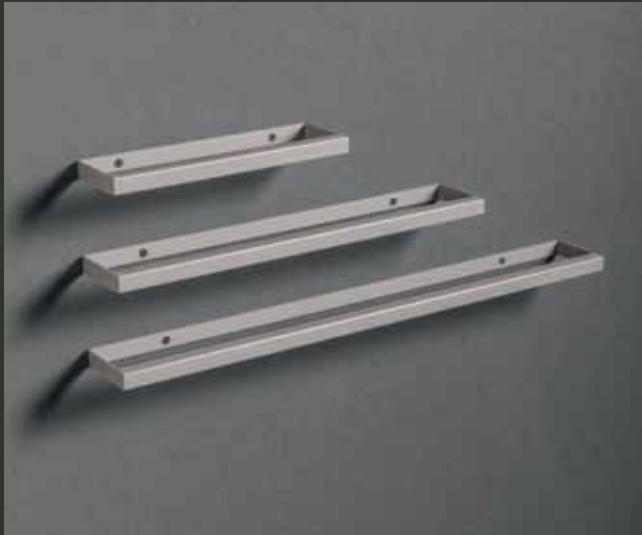

/ T110 . Porta salviette . Towel rail . Handtuchhalter

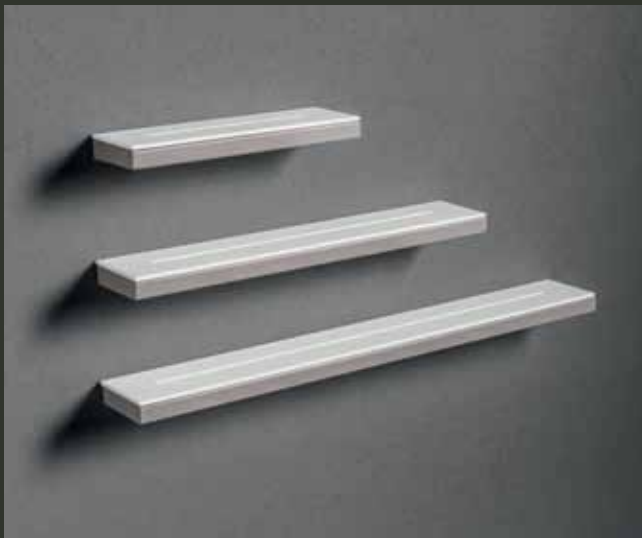

/ T121 . SIGN . Mensole . Shelves . Regal



/ T122 . Mensola bicchiere . Shelf with cup . Becherhalter Regal



/ T105 . Mensola a muro . Wall shelf . Wand Regal



/ T114 . Appendino . Hook . Buegel



/ T108 . Porta salviette isola . Freestanding towell rail  
. Freistehender Handtuchhalter

/ T115 . Lampada . Lamp . Lampe





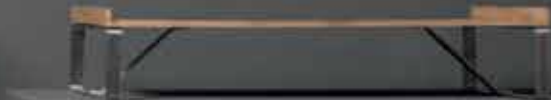

/ TWENTY

/ TW35 . TW45 . TW60

Porta salviette lineare . Linear towel rail . Linearer Handtuchhalter



/ TWAX . Porta salviette asimmetrico . Asymmetric towel rail  
. Asymmetrischer Handtuchhalter



/ TWTT . Porta salviette isola . Freestanding towell rail  
. Freistehender Handtuchhalter



/ TWA1 . Appendino . Hook  
. Buegel



/ TWA2 . Appendino . Hook  
. Buegel

/ TWTR . Vassoio vasca  
 . Bathtub shelf  
 . Tablett fuer Badewanne



TWENTY, è una serie di accessori in acciaio inox AISI 316L dal tratto sottile e dai dettagli raffinati. Una sequenza ragionata di esili fettucce metalliche di forte spessore piegate, inclinate e accostate che, integrate a vassoi in legno sottile o in Corian® GW, danno forma ad una famiglia di elementi funzionali di forte personalità.

TWENTY is a series of accessories in stainless steel AISI 316L characterized by delicate and refined details. They consist of thick metal belts and stripes bent and combined together, which create a collection of functional accessories with a strong personality including also wooden or Corian® GW trays.

TWENTY ist eine Kollektion von Zubehoeren aus Inox Stahl 316L gekennzeichnet durch einen feinen und raffinierten Strich. Sie bestehen aus dicken Baenden aus Metall, gebogen und zusammen gestellt, die integriert zu Tabletten aus Holz oder Corian® GW eine funktionelle Serie bilden, die eine starke Persoenlichkeit hat.



/ TWRK . Rack a muro  
 . Wall rack  
 . Wand rack



/ TWPS . Scopino . Toilet brush  
 . Toilettenbuerste



/ TWPS . Porta scopino a muro  
 . Wall toilet brush . Wand-Toilettenbuerste



/ TWPC . Porta carta  
 . Toilet roll  
 . Toilettenpapierhalter



/ TYPE COLLECTION

/ T103 . STOOL

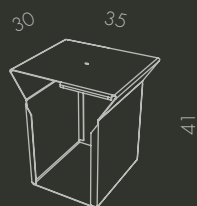

/ T102 . ET. TABLE

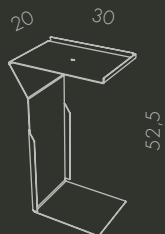

/ T101 . LT. TABLE

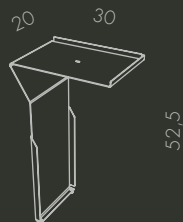

/ T100 . Mensola sospesa  
 . Suspended side table  
 . Wandhaengendes Regal

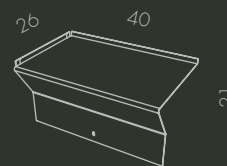

/ T107 . Vassoio rettangolare  
 . Rectangular rack  
 . Rechteckiges Tablett

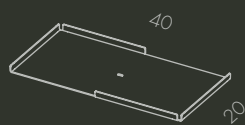

/ T106 . Vassoio quadro  
 . Square rack  
 . Viereckiges Tablett



/ T104 . BRIDGE

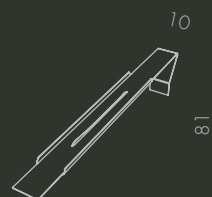

/ T108 . Porta salviette isola  
 . Freestanding towell rail  
 . Freistehender Handtuchhalter

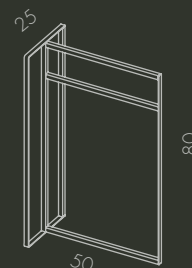

/ T112 . Set scopino  
 . Set toilet brush  
 . Set toilettenbuerste

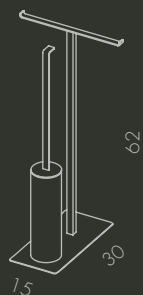

/ T113 . Scopino  
 . Toilet brush  
 . Toilettenbuerste



/ T111 . Porta carta  
 . Toilet roll  
 . Toilettenpapierhalter



/ T110 . Porta salviette  
 . Towel rail  
 . Handtuchhalter

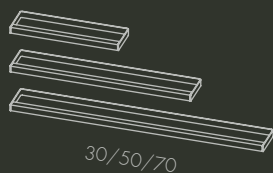

/ T121 . Mensole SIGN  
 . SIGN Shelf  
 . Regal SIGN

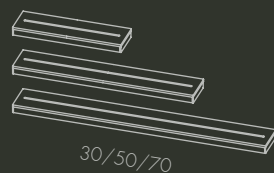

/ T122 T124 . Mensola  
 bicchiere . Shelf with cup  
 . Becherhalter Regal

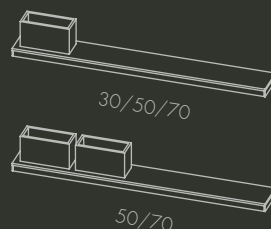

/ T105 . Mensola a muro  
 . Wall shelf  
 . Wand Regal

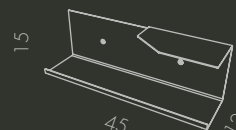

/ T115 . Lampada  
 . Lamp . Lampe

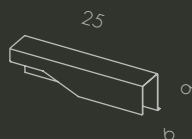

/ T114 . Appendino  
 . Hook . Buegel



/ TWENTY

/ TW35 . TW45 . TW60

. Porta salviette lineare  
. Linear towel rail  
. Linearer Handtuchhalter

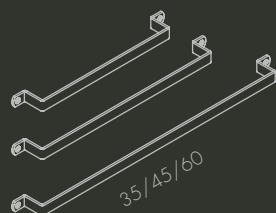

/ TWAX . Porta salviette asimmetrico

. Asymmetric towel rail  
. Asymmetrischer Handtuchhalter

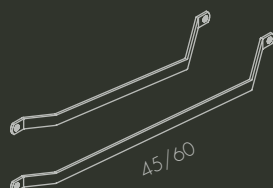

/ TWTT . Porta salviette isola

. Freestanding towel rail  
. Freistehender Handtuchhalter

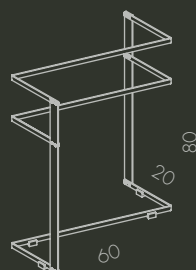

/ TWA1 . Appendino . Hook

. Buegel



/ TWA2 . Appendino . Hook

. Buegel



/ TWPC . Porta carta

. Toilet roll  
. Toilettenpapierhalter

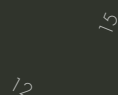

/ TWPS . Porta scopino a muro

. Wall toilet brush  
. Wand-Toilettenbuerste



/ TWPS . Scopino

. Toilet brush  
. Toilettenbuerste



/ TWPC . Rack a muro

. Wall Rack  
. Wand Rack

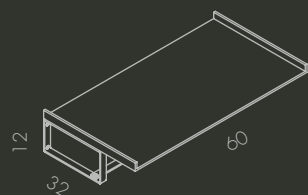

/ TWRK . Vassoio vasca

. Bathtub shelf  
. Tablett Fuer Badewanne

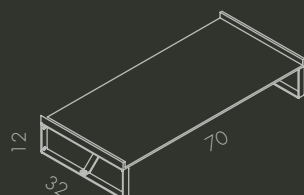

/ Il piano può essere in legno termotrattato o in Corian® Glacier White.

- The tray is available in thermo-treated wood or in Corian® Glacier White.

- Das Tablett ist erhältlich in thermo-behaneltem Holz oder in Corian® Glacier White.



/ LOOP . Design Marco Taietta

/ LOOP XL



/ LOOP L



/ LOOP L+



/ LOOP Freestanding



LOOP è disponibile in Makril bianco o in Velvet Carrara . LOOP is available in white Makril or Velvet Carrara . LOOP ist erhältlich in weiss Makril oder Velvet Carrara



Appoggio . Surface . Aufgesetzt



/ LAVABI . WASHBASINS . WASCHTISCHE



/ MOOD-S

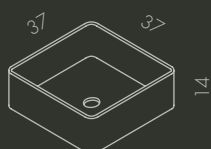

/ MOOD-R

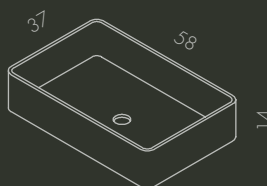

Appoggio . Surface . Aufgesetzt

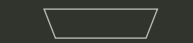

I lavabi MOOD-S e MOOD-R, sono disponibili in bianco nei materiali MINERARMOR® e MINERALSOLID®

- MOOD-S und MOOD-R are available in MINERARMOR® polished finish and in MINERALSOLID® matt finish

- MOOD-S und MOOD-R sind verfügbare in MINERARMOR® poliert und in MINERALSOLID® matt

MINERARMOR® è un materiale composto da cariche minerali naturali (carbonati di calcio e triidrati di alluminio) legate ad una bassa percentuale di resina poliestere. È gradevole al tatto facile da pulire e particolarmente igienico. Il film di gelcoat che riveste la superficie del materiale consente di ottenere ottima resistenza da un punto di vista fisico e, soprattutto, chimico.

- MINERARMOR® is a material consisting of natural mineral charges (calcium carbonate and trihydrated aluminium) with a low percentage of polyester resin. It is nice to the touch, easy to clean and particularly hygienic. The gelcoat layer that covers the material's surface grants a very good physical and chemical resistance.

- MINERARMOR® ist ein Material aus natürlichen Mineralien (Kalziumkarbonat und Aluminium-Trihydrat), gebunden zu einem niedrigen Prozentsatz von Polyesterharz. Dem Tastsinn angenehm und einfach zu reinigen, ist es besonders hygienisch. Die Gelcoat-Folie auf der Oberfläche ermöglicht eine ausgezeichnete physische und chemische Beständigkeit.

- MINERALSOLID® è un materiale composto da 75% cariche minerali naturali (carbonati di calcio e triidrati di alluminio) e 25% resina poliestere. La superficie è rivestita da uno smalto tecnico opaco di tipo poliestere acrilato che consente di ottenere ottime resistenze meccaniche e chimiche. Facile da pulire presenta una finitura morbida al tatto e particolarmente raffinata alla vista.

- MINERALSOLID® is a material consisting by 75% of natural mineral charges (calcium carbonates and trihydrated aluminium) and by 25% of polyester resin. The surface is clad with a matt technical glaze, polyester acrylate type, granting a very good mechanical and chemical resistance. It is easy to clean, nice to the touch and particularly elegant.

- MINERALSOLID® ist ein Material bestehend zu 75% aus natürlichen Mineralien (Kalziumkarbonat und Aluminium-Trihydrat) und zu 25% aus Polyesterharz. Die technische Polyester-Acrylat Beschichtung matt auf der Oberfläche ermöglicht eine ausgezeichnete mechanische und chemische Beständigkeit. Dem Tastsinn angenehm und einfach zu reinigen, ist es dem Auge besonders fein.



/ CUP 6 . 11 . 26  
Design . Makrodesign



I lavabi CUP 6-11-26 da semincasso e da appoggio, sono proposti in in Corian® nelle finiture Glacier White e Deep Nocturne.

The half-recessed and surface washbasins CUP 6-11-26 are available in Corian® Glacier White and Deep Nocturne.

CUP 6-11-26 halb-eingebaut oder aufgesetzt sind in Corian® Glacier White und Deep Nocturne verfügbare.

Appoggio . Surface . Aufgesetzt

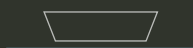

Semincasso . Half-recessed . Halb-eingebaut

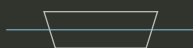

/ CUP  
Design . Makrodesign



Il lavabo CUP, è disponibile nelle finiture in Corian® Glacier White, Deep Nocturne e Makril bianco.

CUP is available in Corian® Glacier White, Deep Nocturne and white Makril.

CUP ist in Corian® Glacier White, Deep Nocturne verfügbare und weiss Makril erhältlich.

Appoggio . Surface . Aufgesetzt

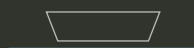

Integrato . Integrated . Integriert

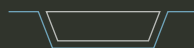



Appoggio . Surface . Aufgesetzt

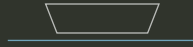

Sottopiano . Undercounter . Unterbau

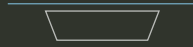

Integrato . Integrated . Integriert

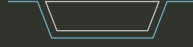

/ CUBE CORIAN® GW  
Design . Makrodesign

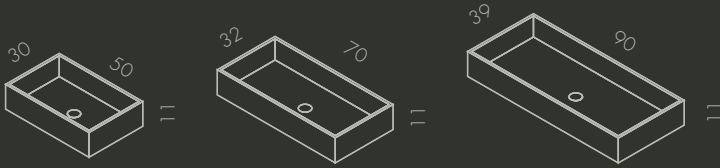

Sottopiano . Undercounter . Unterbau



/ CUBE ACCIAIO INOX  
Design . Makrodesign

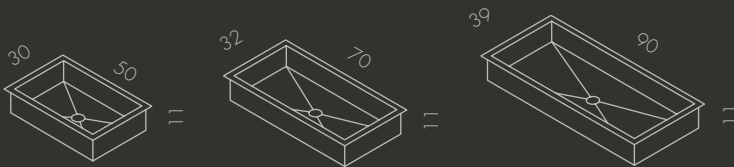





/ ARTIC

Il lavabo ARTIC è disponibile in Makril nei 3 colori, Bianco, Grigio e Tortora e proposto in versione da appoggio e semincasso.

The ARTIC washbasin is available in Makril in 3 colors White, Grey and Tortora and in the versions surface and half-recessed.

ARTIC ist verfügar in den Makril Farben Weiss, Grau und Tortora und als aufgesetztes und halb-eingebautes Becken.

Appoggio . Surface . Aufgesetzt

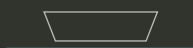

Semincasso . Half-recessed . Halb-eingebaut



/ POLAR

I lavabi POLAR, sono disponibili nei colori Bianco, Grigio e Tortora.

The POLAR washbasin is available in 3 colors White, Grey and Tortora.

POLAR ist verfügar in den Farben Weiss, Grau und Tortora.

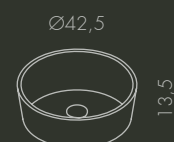



/ TOWER CUP  
Design . Makrodesign

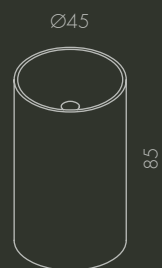

Tower CUP è disponibile in Corian® nelle finiture Glacier White e Deep Nocturne.

- Tower CUP is available in Corian® Glacier White and Deep Nocturne.

- Tower CUP ist verfügbbar in Corian® Glacier White und Deep Nocturne.

/ LOG . TOWER . COLORS

Design . Makrodesign

La serie di lavabi LOG 11 . 26 e TOWER 85 è proposta nei colori Bianco, Grigio, Nero e a richiesta nei colori di gamma. E' disponibile anche la versione total acciaio inox satinato.

- The washbasin collection LOG 11 . 26 and TOWER 85 is available in White, Grey and Black; on request they can be produced in all the colors' range. The above mentioned washbasins are available also fully made in satined stainless steel.

- Die Standard Farben der Becken LOG 11 . 26 und TOWER 85 sind Weiss, Grau und Schwarz; auf Anfrage koennen sie in allen Farben der Serie hergestellt werden. Die Serie LOG ist auch vollstaendig in satiniertem Inox-Stahl verfügbbar .



Corian® GW



Grigio Gray  
Grau



Nero Black  
Schwarz



Corda



Tortora



Moka



Senape Mustard  
Senf



Vanadio



Grigio platino  
Platinum gray  
Platinumgrau



/ LOG 6 . 11 . 26 . Design . Makrodesign

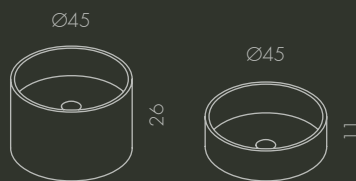

Appoggio . Surface . Aufgesetzt

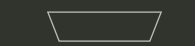

/ TOWER  
Design . Makrodesign

Ø - 45 cm  
H - 85 cm

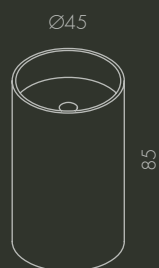

NOTE

NOTE

## **MAKRO** bathroomconcepts

Via 1° Maggio, n.° 15  
35030 - Bastia di Rovolon (PD) - Italia  
Tel.: +39 049 9910951  
Fax: +39 049 9910976  
info@makro.it / www.makro.it

### / LEGENDA

-  
L: larghezza . Width . Breite  
P: Profondità . Depth . Tiefe  
H: Altezza . Height . Höhe

### / THANKS TO

-  
Acca Kappa, Dal Pozzo Arredamenti, Ferm Living, Flos,  
FontanaArte, Gruppo Florim, Il Mercante d'Oriente, Lalu - the  
essence of light, Miniforms, Poliform, Selezione Arredamenti,  
Society Limonta, Vitra, Zero Gloss.

### / CREDITS

-  
Makro . Update catalogue 2015  
Art direction: Marco Taietta + Makrodesign.  
Graphic design: Marco Taietta  
Photography: Thomas Pagani . Emanuele Tortora.  
Text: MKTG Makro.  
Color separation: GM Studio I.  
Printed in Italy by Campisi Tipografia.  
Edition: April 2015

---

### / MADE IN ITALY

-  
Ogni prodotto è pensato, progettato e realizzato interamente in Italia . Every product is completely developed, engineered and realised in Italy  
. Die Produkte sind alle in Italien konzipiert, gestaltet und gefertigt.

### / RISERVA . TERM . BEIFÄLLIG

-  
Makro si riserva di apportare, senza preavviso, modifiche nei materiali, nelle finiture e nei disegni presentati in questo catalogo. Le textures, i colori dei materiali e le finiture hanno valore indicativo in quanto soggetti alle tolleranze dei processi di stampa . Makro reserves the right to change, without prior notice, materials, covers, finishes and drawings of the products presented in this catalogue. The textures and colours of materials and finishes are to consider approximate as they are depending on the tolerances of the printing process . Makro behält sich vor, ohne Ankündigung, Änderungen der in diesem Katalog vorgestellten Materialien, Oberflächen und Zeichnungen vorzunehmen. Die Texturen, Farben der Materialien und Oberflächen sind Richtwerte, da sie den Toleranzen des Druckprozesses unterliegen.





/ MAKRO srl  
Via 1° Maggio, n.° 15  
35030 - Bastia di Rovolon (PD) - Italia  
Tel.: +39 049 9910951  
Fax: +39 049 9910976  
info@makro.it / www.makro.it